

VÁLVULAS E ACOPLAMENTOS HIDRÁULICOS

VALVES AND
QUICK COUPLINGS



ÍNDICE / INDEX

VÁLVULAS E ACOPLAMENTOS HIDRÁULICOS	PAG.	VALVES AND QUICK COUPLINGS
ISO A	73	ISO A
ISO B	74	ISO B
ISO B	75	ISO B
SÉRIE H5000	75	H5000 SERIE
SÉRIE PUSH PULL	76	PUSH PULL SÉRIES
SÉRIE NÓRDIC	76	NORDIC STANDAR
FACE PLANA 350 Bar	77	FLAT FACE SERIES 350Bar
FACE PLANA 250Bar	77	FLAT FACE SERIES 250Bar
SÉRIE MARTELO HIDRÁULICO	78	HYDRAULIC HAMMER SERIES
VÁLVULA DE ROSCA	78	SCREW COUPLINGS
SÉRIE 700 Bar	79	700 Bar SERIES
SÉRIE 1000 Bar	79	1000 Bar SERIES
SÉRIE 1500 Bar	80	1500 Bar SERIES
VÁLVULA PASSADORA 2 VIAS	80	2-WAY HIGH PRESSURE BALL VALVE
VÁLVULA PASSADORA 3 VIAS	81	3-WAY HIGH PRESSURE BALL VALVE
SÉRIE 35	81	SERIES
SÉRIE74	81	74 SERIES
SÉRIE83	81	83 SERIES
SÉRIE93	81	93 SERIES
SÉRIE103	81	103 SERIES
SÉRIE105	81	105 SERIES
SÉRIE106	82	106 SERIES
SÉRIE150	82	150 SERIES
SÉRIE152	82	152 SERIES
SÉRIE124	82	124 SERIES
SÉRIE127	82	127 SERIES
SÉRIE100	82	100 SERIES
SÉRIE165	82	165 SERIES
SÉRIE DP	82	DP SERIES
SÉRIE GR	82	GR SERIES

SÉRIE ISO A
ISO A SERIES

Disponível: Aço Carbono,
AISI 304, AISI 316.
Available: STEEL, AISI
304, AISI 316.



FÊMEA • SOCKET

Norma Standard 7241-1 Series A	CÓDIGO CODE	A	D (mm)	L2 (mm)	W.P. (bar)
	501200.0404	1/4" - BSP	26	51	350
	501200.0606	3/8" - BSP	32	58,5	300
	501200.0808	1/2" - BSP	38	63,5	300
	501200.1212	3/4" - BSP	46	83,5	250
	501200.1616	1" - BSP	55	97	230
	501200.2020	1,1/4" - BSP	70	117	230

MACHO • PLUG

Norma Standard 7241-1 Series A	CÓDIGO CODE	A	D (mm)	L2 (mm)	W.P. (bar)
	502200.0404	1/4" - BSP	11,8	36	350
	502200.0606	3/8" - BSP	17,25	40,5	300
	502200.0808	1/2" - BSP	20,56	46	300
	502200.1212	3/4" - BSP	29	56	250
	502200.1616	1" - BSP	34,3	63	230
	502200.2020	1,1/4" - BSP	44,95	75	230

Tampa p/ Valv. Fêmea
Dust Plug

CÓDIGO CODE	Medida / Size
500100.04	1/4"
500100.06	3/8"
500100.08	1/2"
500100.12	3/4"
500100.16	1"
500100.20	1,1/4"



Tampa p/ Valv. Macho
Dust Cap

CÓDIGO CODE	Medida / Size
500200.04	1/4"
500200.06	3/8"
500200.08	1/2"
500200.12	3/4"
500200.16	1"
500200.20	1,1/4"



SÉRIE ISO B
 ISO B SERIES

Disponível: Aço Carbono,
 AISI 304, AISI 316, Latão.
 Available: STEEL, AISI
 304, AISI 316, Brass.



FÊMEA • SOCKET
MACHO • PLUG

 Norma
 Standard
 7241-1 Series B

CÓDIGO
 CODE

A
D
 (mm)

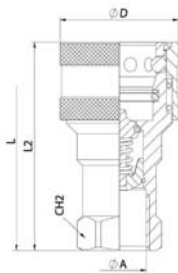
L2
 (mm)

W.P.
 (bar)

501001.0202	1/8" - BSP	22	49	400
501001.0404	1/4" - BSP	27	57,7	380
501001.0606	3/8" - BSP	35	65,5	350
501001.0808	1/2" - BSP	42	74	320
501001.1212	3/4" - BSP	52	90	300
501001.1616	1" - BSP	60	103	280

 Norma
 Standard 7241-1
 Series B

CÓDIGO
 CODE

A
D
 (mm)

L2
 (mm)

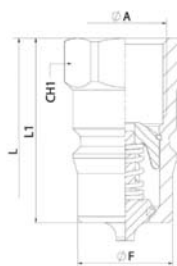
W.P.
 (bar)

502001.0202	1/8" - BSP	10,9	30	400
502001.0404	1/4" - BSP	14,2	36	380
502001.0606	3/8" - BSP	19,1	40,5	350
502001.0808	1/2" - BSP	23,55	46	320
502001.1212	3/4" - BSP	31,45	56	300
502001.1616	1" - BSP	37,8	63	280

Tampa p/ Valv. Fêmea
 Dust Plug

CÓDIGO
 CODE

Medida / Size

500101.04	1/4"
500101.06	3/8"
500101.08	1/2"
500101.12	3/4"
500101.16	1"
500101.20	1,1/4"

Tampa p/ Valv. Macho
 Dust Cap

CÓDIGO
 CODE

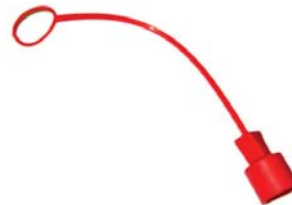
Medida / Size

500201.04	1/4"
500201.06	3/8"
500201.08	1/2"
500201.12	3/4"
500201.16	1"
500201.20	1,1/4"



SÉRIE ISO B
ISO B SERIES

Disponível: Aço, AISI 316,
Latão.
Available: STEEL, AISI
316, Brass.

FÊMEA • SOCKET

Norma
Standard 7241-1
Series B

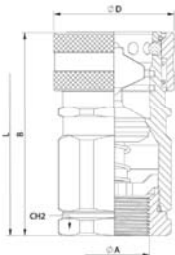

CÓDIGO CODE	A	D (mm)	L2 (mm)	W.P. (bar)
501001.2020	1,1/4" - BSP	75	252	100
501001.2424	1,1/2" - BSP	105	262	100

MACHO • PLUG

Norma
Standard 7241-1
Series B

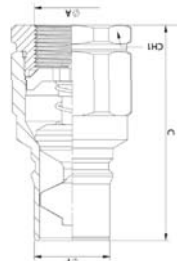

CÓDIGO CODE	A	D (mm)	L2 (mm)	W.P. (bar)
502001.2020	1,1/4" - BSP	44,4	252	100
502001.2424	1,1/2" - BSP	63,27	262	100

SÉRIE H5000
H5000 SERIES

Disponível: Aço, AISI 316,
Latão.
Available: STEEL, AISI
316, Brass.



FÊMEA • FEMALE

Norma
Standard
EATON, TUTHILL,
GROMELLE

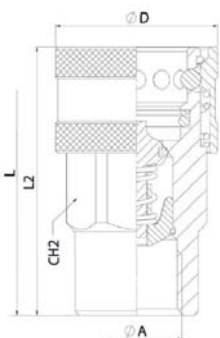

CÓDIGO CODE	A	D (mm)	L2 (mm)	W.P. (bar)
50THA0500100	1/8" - BSP	23,88	41,9	1000
50THA0501100	1/4" - BSP	27,94	50	700
50THA0502100	3/8" - BSP	34,03	58,9	600
50THA0503100	1/2" - BSP	38,1	68,8	500
50THA0504100	3/4" - BSP	48	88,9	400
50THA0505100	1" - BSP	52,06	98,8	300

MACHO • MALE

Norma
Standard
EATON, TUTHILL,
GROMELLE

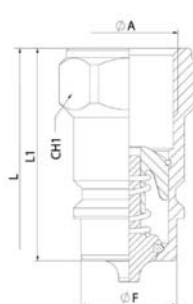

CÓDIGO CODE	A	D (mm)	L2 (mm)	W.P. (bar)
50THA0500200	1/8" - BSP	10,92	27,94	1000
50THA0501200	1/4" - BSP	14,22	35,05	700
50THA0502200	3/8" - BSP	19,05	41,9	600
50THA0503200	1/2" - BSP	20,57	50,03	500
50THA0504200	3/4" - BSP	27,94	62,99	400
50THA0505200	1" - BSP	32,26	70,87	300

SÉRIE PUSH-PULL
PUSH-PULL SERIES

Disponível: Aço, AISI 316.
Available: STEEL, AISI 316.



FÊMEA • FEMALE

Norma Standard 7241-1 Series A

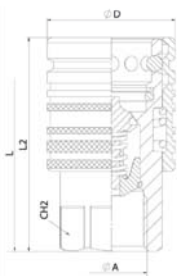

CÓDIGO CODE	A	D (mm)	L2 (mm)	W.P. (bar)
505008.0808P	1/2" - BSP	37,8	63,5	300

MACHO • MALE

Norma Standard 7241-1 Series A

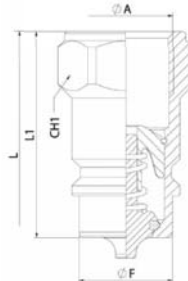

CÓDIGO CODE	A	D (mm)	L2 (mm)	W.P. (bar)
505009.0808P	1/2" - BSP	20,56	48	300

SÉRIE NÓRDICA
NORDIC STANDARD

Disponível: Aço carbono
AISI 316.
Available: Stainless STEEL
AISI 316.



FÊMEA • FEMALE

Norma Standard TEM. Profile

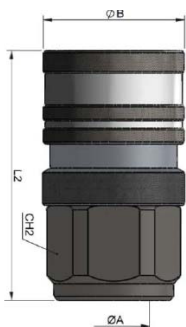

CÓDIGO CODE	A	D (mm)	L2 (mm)	W.P. (bar)
502900.04	1/4" - BSP		64	450
502900.0606	3/8" - BSP	34	60	350
502900.0808	1/2" - BSP	40	65	300
502900.1212	3/4" - BSP	46	72	280
502900.1616	1" - BSP	62	88	250

MACHO • MALE

Norma/Standard TEM. Profile

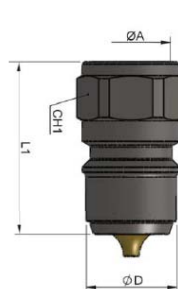

CÓDIGO CODE	A	D (mm)	L2 (mm)	W.P. (bar)
502950.04	1/4" - BSP	11,9	45	450
502950.0606	3/8" - BSP	19,85	38	350
502950.0808	1/2" - BSP	24,7	41,5	300
502950.1212	3/4" - BSP	32,7	46	280
502950.1616	1" - BSP	40,9	54,2	250



**SÉRIE FACE PLANA
350 BAR
FLAT FACE SERIES 350
BAR**

Disponível: Aço carbono
AISI 316.
Available: Stainless STEEL
AISI 316.

FÊMEA • FEMALE

Norma
Standard ISO
16028

CÓDIGO CODE	A	D (mm)	L2 (mm)	W.P. (bar)
502500.0404	1/4" - BSP	28	48	350
502500.0606	3/8" - BSP	32	64,5	350
502500.0808	1/2" - BSP	38	80,5	350
502500.1212	3/4" - BSP	42	78	350
502500.1616	1" - BSP	48	92,5	350
502500.2020	1,1/4" - BSP	55	105	300
502500.2424	1,1/2" - BSP	80	132,5	270
502500.3232	2" - BSP	100	165	80

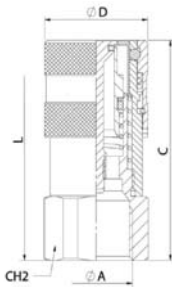

MACHO • MALE

Norma
Standard ISO
16028

CÓDIGO CODE	A	D (mm)	L2 (mm)	W.P. (bar)
502600.0404	1/4" - BSP	16,2	48	350
502600.0606	3/8" - BSP	19,8	62,5	350
502600.0808	1/2" - BSP	24,5	62,5	350
502600.1212	3/4" - BSP	27	70,5	350
502600.1616	1" - BSP	30	82,5	350
502600.2020	1,1/4" - BSP	36	90	300
502600.2424	1,1/2" - BSP	57	111	270
502600.3232	2" - BSP	73	125	80

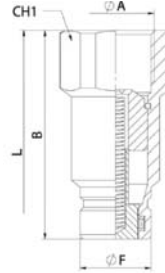

**SÉRIE FACE PLANA
250 BAR
FLAT FACE SERIES 250
BAR**

Disponível: Aço carbono
AISI 316.
Available: Stainless STEEL
AISI 316.

FÊMEA • FEMALE

Norma
Standard ISO
16028

CÓDIGO CODE	A	D (mm)	L2 (mm)	W.P. (bar)
502500.0404S	1/4" - BSP	28	48	300
502500.0606S	3/8" - BSP	32	64,5	300
502500.0808S	1/2" - BSP	38	80,5	300
502500.1212S	3/4" - BSP	42	78	220
502500.1616S	1" - BSP	48	92,5	200
502500.2020S	1,1/4" - BSP	55	105	200
502500.2424S	1,1/2" - BSP	80	132,5	200
502500.3232S	2" - BSP	100	165	160

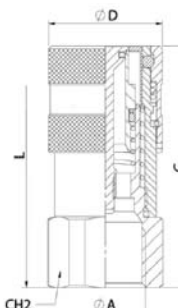

MACHO • MALE

Norma
Standard ISO
16028

CÓDIGO CODE	A	D (mm)	L2 (mm)	W.P. (bar)
502600.0404S	1/4" - BSP	16,2	48	300
502600.0606S	3/8" - BSP	19,8	62,5	300
502600.0808S	1/2" - BSP	24,5	62,5	300
502600.1212S	3/4" - BSP	27	70,5	220
502600.1616S	1" - BSP	30	82,5	200
502600.2020S	1,1/4" - BSP	36	90	200
502600.2424S	1,1/2" - BSP	57	111	200
502600.3232S	2" - BSP	73	125	160

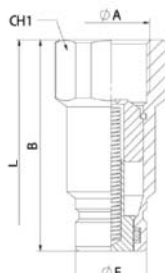



**SÉRIE MARTELO
HIDRÁULICO
VEP SERIES -
HYDRAULIC HAMMER**

Disponível: Aço carbono
AISI 316.
Available: Stainless STEEL
AISI 316.

FÊMEA • FEMALE

Norma
Standard ISO
16028

CÓDIGO CODE	A	D (mm)	L2 (mm)	W.P. (bar)
50FVEP09P	1/2" - BSP	70,8	41,8	550
50FVEP13P	3/4" - BSP	84,8	49,8	550
50FVEP17P	1" - BSP	97,7	58,8	500
50FVEP21P	1.1/4" - BSP	105,8	69,8	470

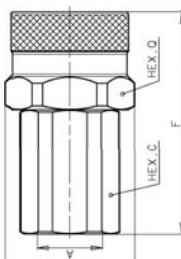

MACHO • MALE

Norma
Standard ISO
16028

CÓDIGO CODE	A	D (mm)	L2 (mm)	W.P. (bar)
50MVEP09P	1/2" - BSP	27	M33X2	550
50MVEP13P	3/4" - BSP	36	M40X3	550
50MVEP17P	1" - BSP	46	M50X3	500
50MVEP21P	1.1/4" - BSP	55	M58X3	470

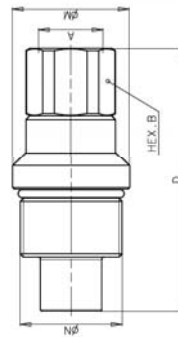

**VÁLVULA ROSCA
SCREW VALVE**

Disponível: Aço carbono
AISI 316.
Available: Stainless STEEL
AISI 316.



FÊMEA • FEMALE

Norma
Standard DIN
3852

CÓDIGO CODE	A	D (mm)	L2 (mm)	W.P. (bar)
502410.0404I	1/4" - BSP	60	M24X2	450
502410.0606I	3/8" - BSP	64	M28X2	450
502410.0808I	1/2" - BSP	70	M36X2	400
502410.1212I	3/4" - BSP	86	M42X2	400
502410.1616I	1" - BSP	100	M48X3	300

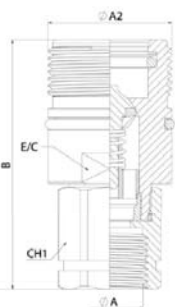

MACHO • MALE

Norma
Standard DIN
3852

CÓDIGO CODE	A	D (mm)	L2 (mm)	W.P. (bar)
502310.0404I	1/4" - BSP	59,3	34	450
502310.0606I	3/8" - BSP	61,2	34	450
502310.0808I	1/2" - BSP	67,5	41,8	400
502310.1212I	3/4" - BSP	80	48	400
502310.1616I	1" - BSP	87,5	59,8	300

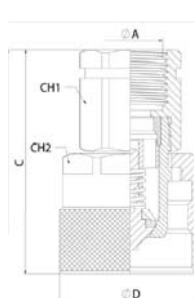

SÉRIE 700 bar
700 bar SERIES

Disponível: Aço carbono
AISI 316.
Available: Stainless STEEL
AISI 316.



FÊMEA • FEMALE

Norma
Standard DIN
3852

CÓDIGO CODE	A	D (mm)	L2 (mm)	W.P. (bar)
T073TGB13	1/4" - BSP	60	28	700
T073TGB17	3/8" - BSP	70	35	700

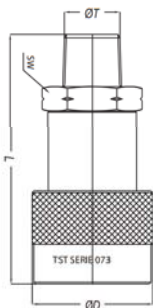

MACHO • MALE

Norma/Standard
ISO 16028

CÓDIGO CODE	A	D (mm)	L2 (mm)	W.P. (bar)
T073NUB13	1/4" - BSP	32	19	700
T073NUB17	3/8" - BSP	38	23	700

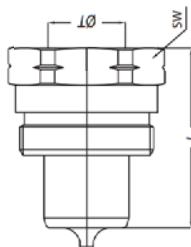

SÉRIE 1000 bar
1000 bar SERIES

Disponível: Aço carbono
AISI 316.
Available: Stainless STEEL
AISI 316.



FÊMEA • FEMALE

Norma
Standard - 1000
BAR

CÓDIGO CODE	A	D (mm)	L2 (mm)	W.P. (bar)
50CJ115.1200	1/4" - BSP	61,5	28	1000
50CJ115.1404	3/8" - BSP	63,5	28	1000

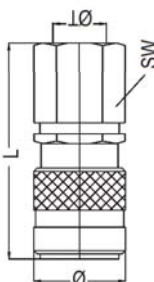

MACHO • MALE

Norma
Standard - 1000
BAR

CÓDIGO CODE	A	D (mm)	L2 (mm)	W.P. (bar)
50CJ115.6202	1/4" - BSP	38	22	1000
50CJ115.6402	3/8" - BSP	39,5	24	1000

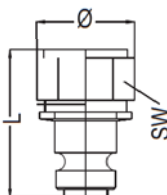



SÉRIE 1500 bar
1500 bar SERIES

Disponível: Aço carbono
AISI 316.
Available: Stainless STEEL
AISI 316.

FÊMEA • FEMALE

Norma Standard DIN 3852

CÓDIGO CODE	A	D (mm)	L2 (mm)	W.P. (bar)
50CJ116.1201	1/8" - BSP	54	28	1500
50CJ116.1202	1/4" - BSP	61,5	28	1500

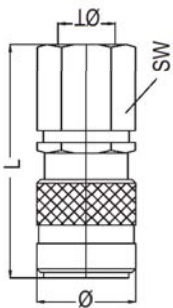

MACHO • MALE

Norma Standard ISO 16028

CÓDIGO CODE	A	D (mm)	L2 (mm)	W.P. (bar)
50CJ116.6201	1/8" - BSP	33,5	17	1500
50CJ116.6202	1/4" - BSP	38	22	1500

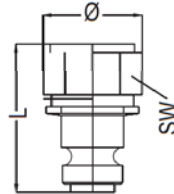

VÁLVULA PASSADORA 2 VIAS
2-WAY HIGH PRESSURE BALL VALVE

Disponível em aço carbono e AISI 316.
Available: Stainless steel AISI 316.

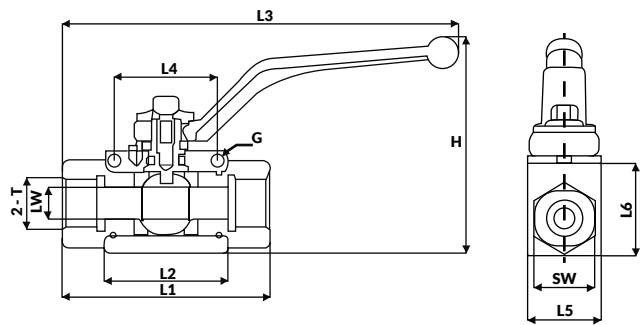

REF. CODE	Pol. Inch	PRESSÃO MAX. SERVIÇO Max. Working Pressure	Ø Lw	L1	L2	L3	H	G	L4	L5	L6	T
506000.04	1/4"	500 bar	Ø6	69	40	152	78	4.5	26	26	33	1/4BSPP(NPT)
506000.06	3/8"	500 bar	Ø10	71	42	154	84	5.2	32	33	38	3/8BSPP(NPT)
506000.08	1/2"	500 bar	Ø13	82	48	159	86	6.5	37.5	36	40	1/2BSPP(NPT)
506000.12	3/4"	315 bar	Ø20	96	62	219	119	6.5	45	49	57	3/4BSPP(NPT)
506000.16	1"	315 bar	Ø25	113	66	228	128	8.5	55	58	65	1BSPP(NPT)
506000.20	1.1/4"	315 bar	Ø25	120	66	231	128	8.5	55	58	65	1-1/4BSPP(NPT)
506000.24	1.1/2"	315 bar	Ø25	130	66	236	128	8.5	55	58	65	1-1/2BSPP(NPT)

VÁLVULA PASSADORA 3 VIAS
3 - WAY HIGH PRESSURE BALL VALVE

Disponível em aço carbono e AISI 316.
Available: Stainless steel AISI 316.

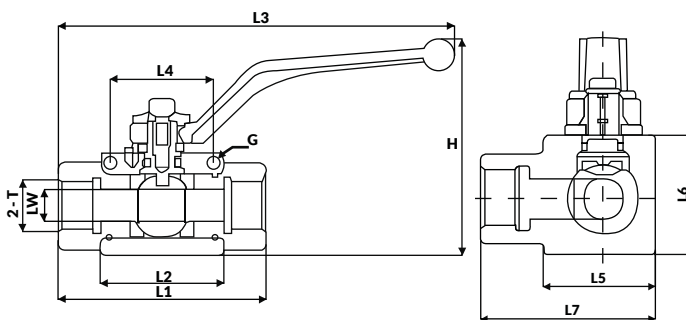

REF. CODE	Pol. Inch	PRESSÃO MÁX. SERVIÇO Max. Working Pressure	Ø Lw	L1	L2	L3	H	L4XG	L5	L6	L7	T
506001.04	1/4"	500 bar	Ø6	69	40	152	78	26X4.5	29	33	47.5	1/4BSPP(NPT)
506001.06	3/8"	500 bar	Ø10	71	42	154	84	32X5.2	35	38	52	3/8BSPP(NPT)
506001.08	1/2"	500 bar	Ø13	82	48	159	86	37.5X6.5	38	40	59	1/2BSPP(NPT)
506001.12	3/4"	315 bar	Ø20	96	62	219	119	45X6.5	52	57	72	3/4BSPP(NPT)
506001.16	1"	315 bar	Ø25	113	66	228	128	55X8.5	61	65	85	1BSPP(NPT)
506001.20	1-1/4"	315 bar	Ø25	120	66	231	128	55X8.5	61	65	85	1-1/4BSPP(NPT)
506001.24	1-1/2"	315 bar	Ø25	130	66	236	128	55X8.5	61	65	118	1-1/2BSPP(NPT)

NOVAS SÉRIES • NEW SERIES

CONSULTE-NOS.

CONTACT US.



SERIE 35



SERIE 74



SERIE 83



SERIE 103



SERIE 93



SERIE 105



SERIE 106



SERIE 150



SERIE 152



SERIE 124



SERIE 127



SERIE 100



SERIE 165



SERIE DP



SERIE GR